

MASSA OHNE TOLERANZ SIND KEINE PRUEFMASSA
 DIMS. WITHOUT TOLERANCE ARE NOT CONTROL DIMS.

Diese Kopie unterliegt nicht dem
 Weidmüller - Änderungsdienst!

DIE DEUTSCHE VERSION IST VERBINDLICH
 THE GERMAN VERSION IS BINDING

Die Informationen zu Artikel-Nummern beinhalten keine Lieferzusage! BL-1/0 3.5 /10 FP LED

BL 1/0 3.5 10 mit LED

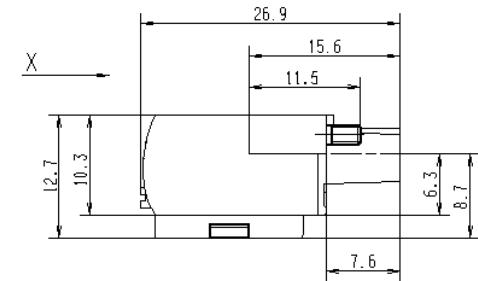
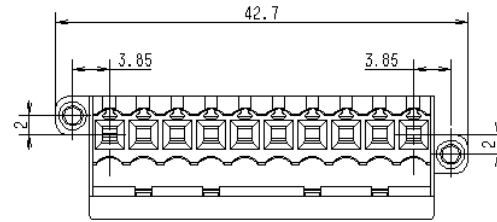
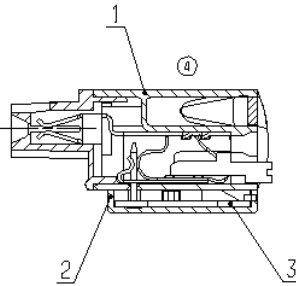

Ansicht X

⑥

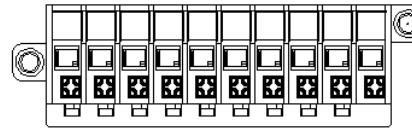

Ansicht X

BL 1/0 3.5 /10 FP M ⑥

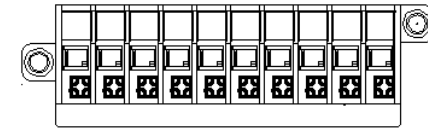

BL 1/0 3.5 10 ohne LED

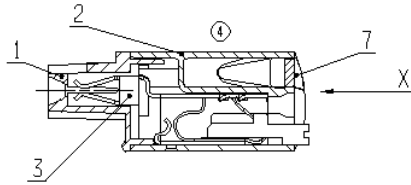

Ansicht X
 BL-1/0 3.5/10 FP

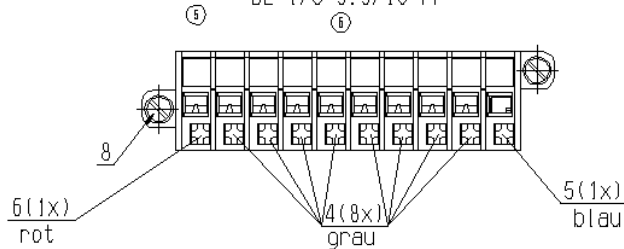

BL-1/0 3.5 /10 F LED

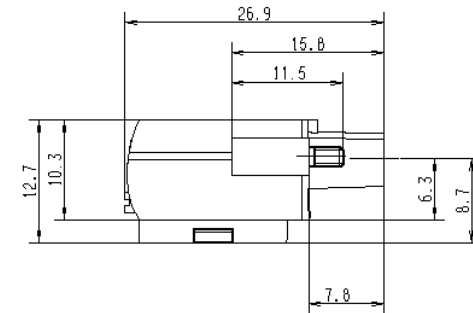
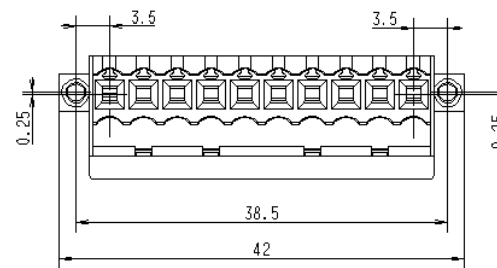

M 1:1

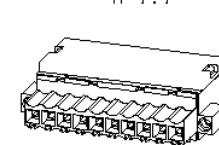

BL-1/0 3.5 /10 F M	179207
BL-1/0 3.5 /10 FP M	179208
BL-1/0 3.5 /10 F LED	178909
BL-1/0 3.5 /10 FP LED	178908
BL-1/0 3.5 /10 F	177988
BL-1/0 3.5 /10 FP	177987
	unbedruckt

Ausführungsvorschrift Frontplatte

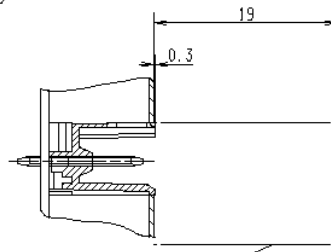
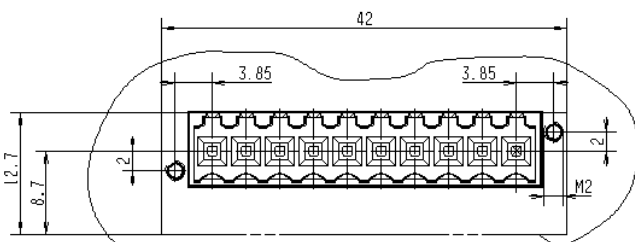

M2 Bohrungen nur Ausführung BL-1/0 3.5/10 FP

Bauraum BL 1/0

⑥	23.158/5	4
⑤	14.02.01 Dom	3
④	22.082/5	2
③	15.04.01 LCR	
②	28.11.00 Dom	

MODIFICATION

DATE	NAME
DRAWN 28.01.00	Länge
RESPONSIBLE 28.01.00	Länge
CHECKED 28.01.00	Keil
APPROVED 28.01.00	Endree

Weidmüller

3 29838 ⑥
 DRAWING NO. (ISSUE NO.)
 SHEET: 1 OF 1 SHEETS

BL-1/0 3.5 /10 Fx

SCALE: 2:1, 1:1
 SUPERSEDES: .
 SUPERSEDED BY: .

PRODUCT FILE: BL 1/0 3.5

792168 CPC

SCHUTZVERMERK DIN 34 BEACHTEN
 PROTECTION REMARK DIN 34 MUST BE OBSERVED