

Data sheet

750-812

**MODBUS PROGRAMMABLE FIELDBUS CONTROLLER RS 485 / 150 - 19200 Baud
CARRIER RAIL DIN 35 CAGE CLAMP CONNECTION**



Technical data

Package size 1 piece.

Max. no. of nodes	99 with repeater
Max. no. Of I/O points	ca. 6000 (depends on Master)
Transmission medium	shielded Cu-cable 2 (4) x 0.25 mm ²
Max. length of fieldbus segment	1200 m (depends on the baud rate / on the cable)
Baud rate	150 (1200) Baud ... 19.2 (115.2) kBaud
Buscoupler connection	1 x D-SUB 9; socket
Programming	WAGO-I/O-PRO 32
IEC 61131-3	AWL, KOP, PUP, ST, AS
UL 508	E175199, UL 508
Conformity marking	CE
Max. no. of I/O modules	64
Max. fieldbus input image (Byte)	1024 Byte
Max. fieldbus output image (Byte)	1024 Byte
Input variables	512 Byte
Output variables	512 Byte
Configuration	automatic and via switches
Program memory	32 kByte
Data memory	32 kByte
Non-volatile memory (retain)	8 kByte
Cycle time	< 3 ms for 1000 statements / 256 dig. I/O's
Voltage supply	DC 24 V (-25% / + 30%)
Input current (max)	500 mA
Efficiency of the power supply	87 %

Data sheet

750-812

MODBUS PROGRAMMABLE FIELDBUS CONTROLLER RS 485 / 150 - 19200 Baud CARRIER RAIL DIN 35 CAGE CLAMP CONNECTION

Internal current consumption	350 mA
Total current for the I/O modules	1650 mA
Isolation	500 V system / supply
Voltage via power jumper contacts (max)	DC 24 V (-25% / + 30%)
Current via power jumper contacts (max)	DC 10 A
Operating temperature	0 °C ... + 55 °C
Storage temperature	-25 °C ... +85 °C
Relative air humidity	95 %
Vibration resistance	acc. IEC 60068-2-6
Shock resistance	acc. IEC 60068-2-27
Degree of protection	IP 20
EMC immunity to interference	acc. EN 50082-2 (96)
EMC emission of interference	per EN 50081-1 (93)
EMC marine applications - noise proof	gem. Germanischer Lloyd (1997)
EMC marine applications - noise transmission	gem. Germanischer Lloyd (1997)
Cross section from [mm ²]	0.08 mm ²
Cross section to [mm ²]	2.5 mm ²
Cross section from [AWG]	28 AWG
Cross section to [AWG]	14 AWG
Weight	205 g
Color	light gray
Height	65 mm
Height	2.56 in
Width	51 mm
Width	2.008 in
Depth	100 mm
Depth	3.937 in
Strip length from	8 mm
Strip length to	9 mm
Strip length	0.33 in
Manuals	

Data sheet

750-812

**MODBUS PROGRAMMABLE FIELDBUS CONTROLLER RS 485 / 150 - 19200 Baud
CARRIER RAIL DIN 35 CAGE CLAMP CONNECTION**

Approval	Voltage	Current	Approval number	Notes
BV			13453/A0BV	
cULus	24		E175199	
DNV			A-8471	
GL			40197-01HH	
LR			02/20036	
Rina			MAC30402CS1	

Data sheet

750-812

**MODBUS PROGRAMMABLE FIELD BUS CONTROLLER RS 485 / 150 - 19200 Baud
CARRIER RAIL DIN 35 CAGE CLAMP CONNECTION**

Accessories	Item number
ALUMINUM CARRIER RAIL 35 X 7.5 MM, 1.5 MM / 0.059 IN THICK	210-196
COMMUNICATION CABLE	750-920
COPPER CARRIER RAIL 35 X 15 MM, 2.3 MM / 0.091 IN THICK	210-198
END MODULE CARRIER RAIL DIN 35	750-600
Individual wire jumpers	individual jumper
IP65 ENCLOSURE SHEET STEEL	850-811
IP65 ENCLOSURE SHEET STEEL	850-812
IP65 ENCLOSURE SHEET STEEL	850-813
MARKERS FOR GROUP MARKER CARRIERS MARKER CARD DIN A4 (160 MARKERS)	750-100
MINIATURE WSB QUICK MARKING STRIPS PLAIN	248-501
MINIATURE WSB QUICK MARKING STRIPS PLAIN	248-501/000-002
MINIATURE WSB QUICK MARKING STRIPS PLAIN	248-501/000-005
MINIATURE WSB QUICK MARKING STRIPS PLAIN	248-501/000-006
MINIATURE WSB QUICK MARKING STRIPS PLAIN	248-501/000-007
MINIATURE WSB QUICK MARKING STRIPS PLAIN	248-501/000-012
MINIATURE WSB QUICK MARKING STRIPS PLAIN	248-501/000-017
MINIATURE WSB QUICK MARKING STRIPS PLAIN	248-501/000-023
MINIATURE WSB QUICK MARKING STRIPS PLAIN	248-501/000-024
Open individual wire jumpers ends	individual jumper open end
POWER SUPPLY PASSIVE	750-613
POWER SUPPLY UNIT PRIMARY TRIGGERED	787-903
POWER SUPPLY UNIT PRIMARY TRIGGERED	787-904
POWER SUPPLY UNIT PRIMARY TRIGGERED	787-912
PROFINET IO FIELD BUS COUPLER 100 Mbit	750-340
PROFINET PROGRAMMABLE FIELD BUS CONTROLLER 100 Mbit	750-840
RAIL-MOUNTED MODULES - POWER SUPPLY UNITS WITH UNIVERSAL MOUNTING CARRIER	288-808
RAIL-MOUNTED MODULES - POWER SUPPLY UNITS WITH UNIVERSAL MOUNTING CARRIER	288-809
RAIL-MOUNTED MODULES - POWER SUPPLY UNITS WITH UNIVERSAL MOUNTING CARRIER	288-810
RAIL-MOUNTED MODULES - POWER SUPPLY UNITS WITH UNIVERSAL MOUNTING CARRIER	288-812
RAIL-MOUNTED MODULES - POWER SUPPLY UNITS WITH UNIVERSAL MOUNTING CARRIER	288-813
RAIL-MOUNTED MODULES - POWER SUPPLY UNITS WITH UNIVERSAL MOUNTING CARRIER	288-814
RAIL-MOUNTED MODULES - POWER SUPPLY UNITS WITH UNIVERSAL MOUNTING CARRIER	288-815
SCREWDRIVER Type 1, bar (2,5 x 0,4) mm	210-119

Data sheet

750-812

MODBUS PROGRAMMABLE FIELD BUS CONTROLLER RS 485 / 150 - 19200 Baud CARRIER RAIL DIN 35 CAGE CLAMP CONNECTION

SCREWDRIVER Type 2, bar (3,5 x 0,5) mm	210-120
SCREWDRIVER WITH PARTIALLY INSULATED SHAFT Type 1, bar (2,5 x 0,4) mm	210-619
SCREWDRIVER WITH PARTIALLY INSULATED SHAFT Type 2, bar (3,5 x 0,5) mm	210-620
SCREWLESS END STOP 10 MM / 0.394 IN WIDE	249-117
SHIELD CLAMPING SADDLE 11 MM / 0.433 IN WIDE	790-108
SHIELD CLAMPING SADDLE 19 MM / 0.741 IN WIDE	790-116
SHIELD CLAMPING SADDLE 27 MM / 1.053 IN WIDE	790-124
SHIELD CLAMPING SADDLE 43 MM / 1.677 IN WIDE	790-140
STEEL CARRIER RAIL 35 X 15 MM, 1.5 MM / 0.059 IN THICK	210-114
STEEL CARRIER RAIL 35 X 15 MM, 1.5 MM / 0.059 IN THICK	210-197
STEEL CARRIER RAIL 35 X 15 MM, 1.5 MM / 0.059 IN THICK	210-506
STEEL CARRIER RAIL 35 X 15 MM, 1.5 MM / 0.059 IN THICK	210-508
STEEL CARRIER RAIL 35 X 15 MM, 2.3 MM / 0.091 IN THICK	210-118
STEEL CARRIER RAIL 35 X 15 MM, 2.3 MM / 0.091 IN THICK	210-548
STEEL CARRIER RAIL 35 X 7.5 MM, 1 MM / 0.039 IN THICK	210-112
STEEL CARRIER RAIL 35 X 7.5 MM, 1 MM / 0.039 IN THICK	210-113
STEEL CARRIER RAIL 35 X 7.5 MM, 1 MM / 0.039 IN THICK	210-504
STEEL CARRIER RAIL 35 X 7.5 MM, 1 MM / 0.039 IN THICK	210-505
STEEL IP65 ENCLOSURES 10/100 Mbit/s	750-841/025-000
STEPPER MODULE FOR THE WAGO-I/O-SYSTEM 750	750-670
STÜTZELKO-MODUL SMOOTHES UNSTABLE DC 24 V POWER SUPPLIES	288-824
WAGO RADIO ADAPTER	750-921

Data sheet

750-812

MODBUS PROGRAMMABLE FIELDBUS CONTROLLER RS 485 / 150 - 19200 Baud CARRIER RAIL DIN 35 CAGE CLAMP CONNECTION

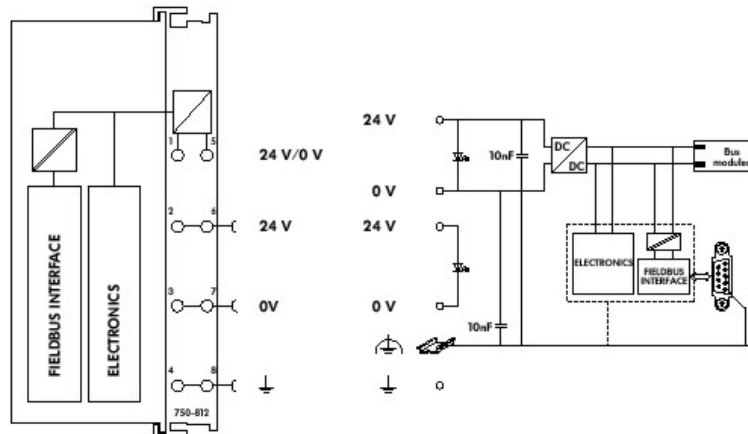
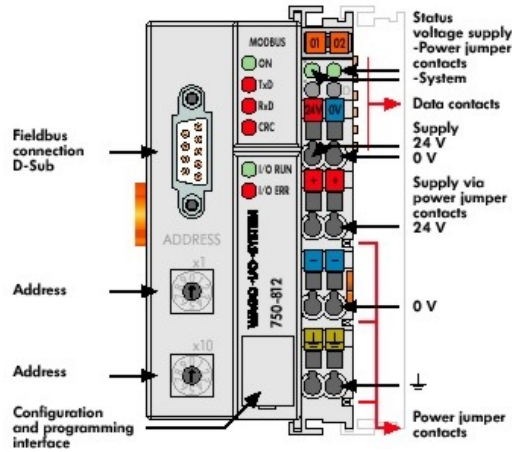

Data sheet

750-812

**MODBUS PROGRAMMABLE FIELDBUS CONTROLLER RS 485 / 150 - 19200 Baud
CARRIER RAIL DIN 35 CAGE CLAMP CONNECTION**

The programmable fieldbus controller for MODBUS is an expansion of the WAGO-I/O-SYSTEM. This controller combines the WAGO fieldbus coupler for MODBUS with the functionality of a PLC. Programming of the application is done with WAGO-I/O-PRO 32 in accordance with IEC 61131-3, covering all 5 programming languages. The programmer can access all fieldbus and I/O data.

Characteristics and use:

- | The use of decentralized control can better support a PLC or PC
- | Signal pre-processing reduces fieldbus transmissions
- | Complex applications can be divided into multiple tasks
- | Tasks can be prioritized
- | Peripheral equipment can be controlled directly, resulting in faster system response times
- | Programmable response in the event of a fieldbus failure
- | Simple, self-sufficient control

Data sheet

750-812

**MODBUS PROGRAMMABLE FIELDBUS CONTROLLER RS 485 / 150 - 19200 Baud
CARRIER RAIL DIN 35 CAGE CLAMP CONNECTION**
