

THESE DRAWINGS ARE THE PROPERTY OF QUALTEK ELECTRONICS AND NOT TO BE REPRODUCED FOR OR COMMUNICATED TO A THIRD PARTY WITHOUT THE EXPRESS WRITTEN PERMISSION OF AN OFFICER OF QUALTEK ELECTRONICS.

| REVISION | | | |
|----------|-------------|------|----------|
| REV. | DESCRIPTION | DATE | APPROVED |
| | | | |
| | | | |
| | | | |

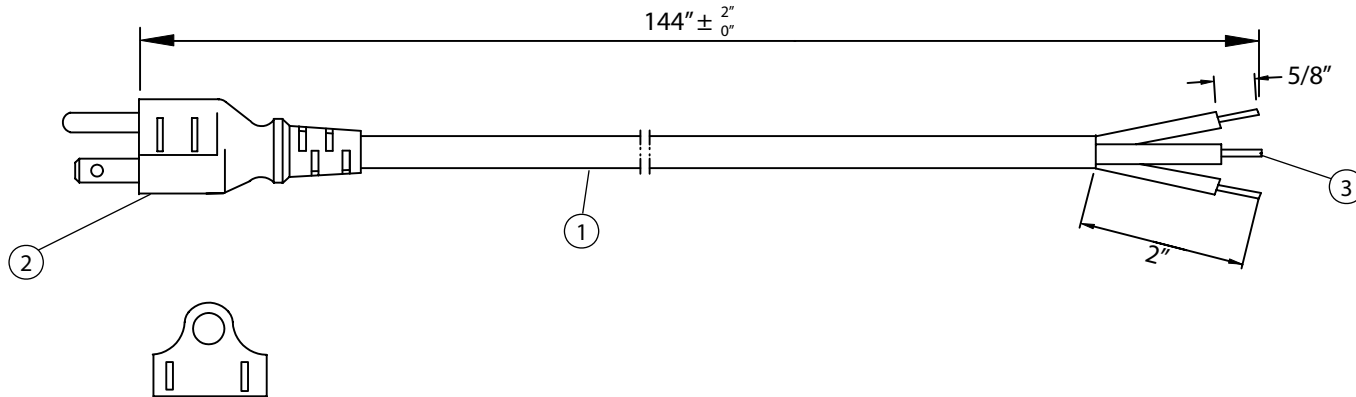

CONTROLLED

NOTES:

1. CORDAGE: SJT, 18AWG / 3C, UNSHIELDED, CEE COLOR CODE, TEMP. RATING: 60°C, RATING: 125V 10A, JACKET COLOR: BLACK
2. PLUG: NEMA 5-15P
3. OTHER END: ROJ 2" STRIP 5/8"
4. APPROVALS: UL, CSA
5. ROHS COMPLIANT

| Dim range (mm) | Tolerance +/- (mm) | Qualtek Electronics Corp. PPC DIVISION | | |
|----------------|--------------------|---|----------------|--|
| 0-1 | 0.15 | Part Number: | 311275-01 | RoHS Compliant |
| 1-6 | 0.20 | Description: | POWER CORD | |
| 6-18 | 0.30 | | UNIT: in | |
| 18-50 | 0.50 | Drawn / Date | Checked / Date | Approved / Date |
| 50-120 | 0.70 | R.Nuti 09-09-09 | 09-09-09 | LY / 09-09-09 |
| 120-250 | 0.90 | | | |
| 250-500 | 1.20 | | | |