

UL Listed Power Distribution Blocks

The requirements of the National Electric Code (NEC) and UL508A now require many electrical panels to carry a Short Circuit Current Rating (SCCR). These new Power Distribution Blocks are listed to UL1953. The feeder spacing requirements of UL508A are achieved with these blocks.

















Shown left to right: FPB23570 and FPB33588

Specifications:

- Connector Housings, Thermoplastic, UL 94 V-0, RTI 125°C
- Insulator Base Plate, Phenolic Laminate, UL 94 V-0, RTI 130°C
- Wire Connectors - Tin Plated Aluminum, Rated for Copper or Aluminum Wire (CU & AL)
- Short Circuit Current Rating up to 100kA (100kA SCCR Rating with copper conductors only. Requires specific over-current protection device.)
- Flexible Stranded Wire Compliant
- Safety hinged cover available as accessory, 1 cover per pole (CH1321 and CH1331) - see page 58
- UL 508A Feeder Circuit Terminal Spacing for up to 600 Volts
- Rated up to 335 Amp, 600 Volts
- Line side conductor up to 600 kcmil
- Distribution, up to twelve conductors per pole
- Investigated to UL 1953
- UL Category and File: QPQS.E309401
- RoHS Compliant

To order blocks with cover installed, add "CH" to end of part number - **if ordered with cover installed, blocks are UL Recognized**

Catalog #	Current Amps (CU)	Connector Material	LINE SIDE			LOAD SIDE			SCCR RMS Sym Amps 600 volt Max
			Wire Range AWG/kcmil	Openings Per Pole	Connector Config.	Wire Range AWG/kcmil	Openings Per Pole	Connector Config.	
FPB23570	175	Aluminum	2/0 - #14	1		#4 - #14	4		100,000
FPB23572	175	Aluminum	2/0 - #14	1		2/0 - #14	1		100,000
FPB23574	175	Aluminum	2/0 - #14	1		1/4 - 20 stud	1		100,000
FPB23580	175	Aluminum	2/0 - #14	1		#4 - #14	6		100,000
FPB33553	335	Aluminum	400 kcmil - #6	1		#2 - #14	6		100,000
FPB33588	335	Aluminum	600 kcmil - #2	1		1/0 - #14	3		100,000
						#2 - #14	6		
FPB33595	335	Aluminum	600 kcmil - #2	1		#4 - #14	12		100,000

See page 38 for dimensional information.

UL Listed Power Distribution Blocks

FPB23XXX

UL Listed
Power Distribution Blocks

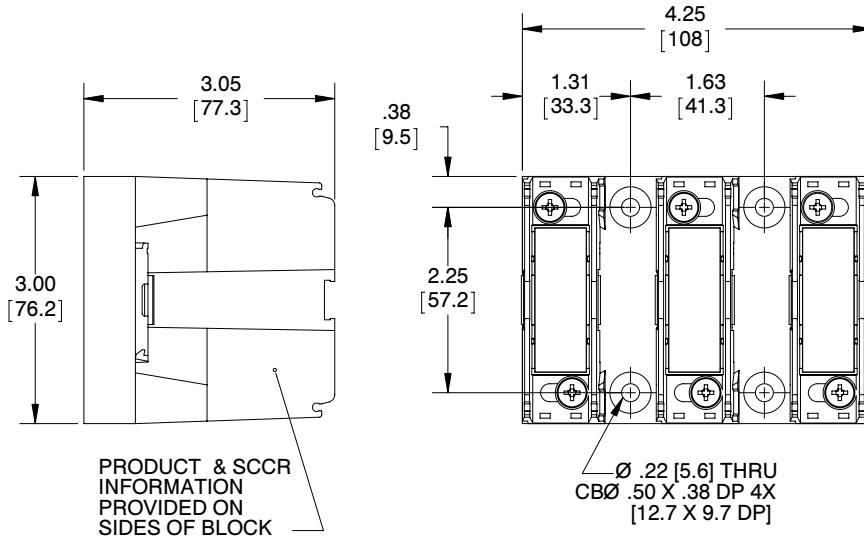

FPB33XXX

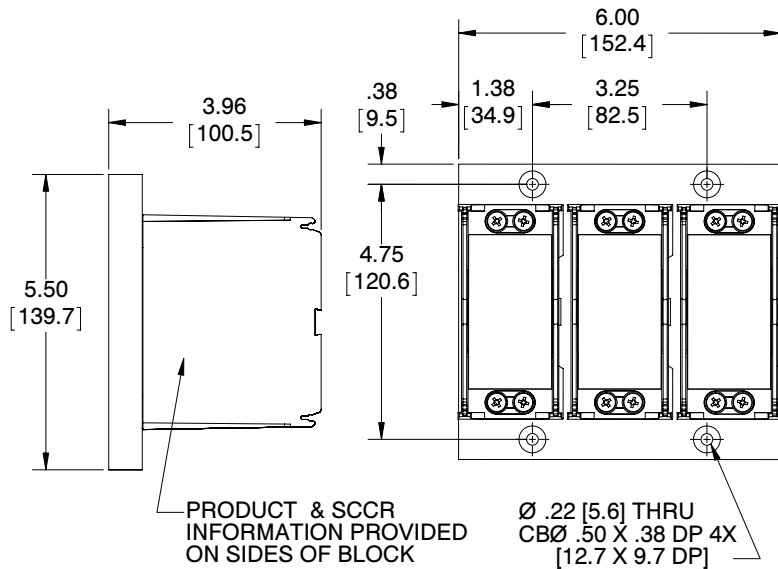

For electronic drawings or 2D/3D CAD data, submit request at www.marathonsp.com/drawings.html