

Features

Relay module with forcibly guided contacts

- 7S.12 with 2 pole (1 NO + 1 NC)
- 7S.14 with 4 pole (2 NO + 2 NC and 3 NO + 1 NC)
- 7S.16 with 6 pole (4 NO + 2 NC)

- For safety applications, with class A forcibly guided contact relays (EN 50205)
- For functional reliability in machinery and plant engineering according to EN 13849-1
- For railway applications; materials compliant with fire and smoke characteristics (UNI 11170-3); mechanical and climatic characteristics compliant with EN 61373 and EN 50155
- DC and AC supply versions
- 24 and 110 V DC versions with extended operating range (0.7...1.25) U_N
- Coil status visual indication with LED
- 35 mm rail (EN 60715) mount

Screwless terminal



* Single contact current ≤ 6 A,
total NO contacts current ≤ 12 A

For outline drawing see page 6

<p>• 2 pole (1 NO + 1 NC)</p>	<p>• 4 pole (2 NO + 2 NC and 3 NO + 1 NC)</p>	<p>• 6 pole (4 NO + 2 NC)</p>

Contact specification		1 NO + 1 NC	2 NO + 2 NC, 3 NO + 1 NC	4 NO + 2 NC
Contact configuration		1 NO + 1 NC	2 NO + 2 NC, 3 NO + 1 NC	4 NO + 2 NC
Rated current / Max. peak current	A	6/15	6*/12	6*/12
Rated switching voltage	V AC (50/60 Hz)	250	250	250
Rated load AC1	VA	1,500	1,500	1,500
Rated load AC15 (230 V AC)	VA	700	500	500
Breaking capacity DC1: 30/110/220 V	A	6/0.6/0.2	6/0.6/0.3	6/0.6/0.3
Breaking capacity DC13: 24 V	A	1	1	1
Minimum switching load	mW (V/mA)	60 (5/5)	60 (5/5)	60 (5/5)
Standard contact material		AgNi + Au (5 μ m)	AgNi with notched crown	AgNi with notched crown
Coil specification				
Nominal voltage (U_N)	V AC (50/60 Hz)	110...125 - 230...240	110...125 - 230...240	110...125 - 230...240
	V DC	12 - 24	12 - 24 - 110	12 - 24 - 110
Rated power	VA (50 Hz) / W	2.3/1	2.3/1	2.3/1
Operating range	AC	(0.85...1.1) U_N	(0.85...1.1) U_N	(0.85...1.1) U_N
	DC	(0.8...1.2) U_N	(0.8...1.2) U_N	(0.8...1.2) U_N
	DC extended range (24 and 110 V only)	(0.7...1.25) U_N	(0.7...1.25) U_N	(0.7...1.25) U_N
Holding voltage	AC/DC	0.45 U_N /0.45 U_N	0.55 U_N /0.55 U_N	0.55 U_N /0.55 U_N
Must drop-out voltage	AC/DC	0.1 U_N /0.1 U_N	0.1 U_N /0.1 U_N	0.1 U_N /0.1 U_N
Technical data				
Mechanical life	cycles	10 · 10 ⁶	10 · 10 ⁶	10 · 10 ⁶
Electrical life at rated load AC1	cycles	100 · 10 ³	100 · 10 ³	100 · 10 ³
Operate / release time	ms	7/11	12/10	12/10
Insulation between coil and contacts (1.2/50 μ s)	kV	6	6 (4 against 13-14)	6 (4 against 13-14)
Dielectric strength between open contacts	V AC	1,500	1,500	1,500
Ambient temperature	°C	-40...+70	-40...+70	-40...+70
Protection category		IP 20	IP 20	IP 20

Approvals (according to type)	
--------------------------------------	--

Ordering information

Example: 7S series Relay module with forcibly guided contacts, 6 contact (4 NO + 2 NC) 6 A, supply voltage 24 V DC.

7 S . 1 6 . 9 . 0 2 4 . 0 4 2 0

Series _____
Type _____
 1 = 22.5 mm wide, cage-clamp terminals
Output _____
 2 = 2 contacts
 4 = 4 contacts
 6 = 6 contacts
Supply version _____
 8 = AC (50 /60 Hz)
 9 = DC
Supply voltage _____
 See page 5

Special versions
 0 = Standard
NO and NC contacts
 11 = 1 NO + 1 NC
 22 = 2 NO + 2 NC
 31 = 3 NO + 1 NC
 42 = 4 NO + 2 NC
Contact material
 0 = AgNi
 5 = AgNi+Au 5 µm

Codes, Preferred selections for best availability are shown in bold.

7S.12.9.012.5110	7S.14.9.012.0220	7S.16.9.012.0420
7S.12.9.024.5110	7S.14.9.012.0310	7S.16.9.024.0420
7S.12.8.120.5110	7S.14.9.024.0220	7S.16.9.110.0420
7S.12.8.230.5110	7S.14.9.024.0310	7S.16.8.120.0420
	7S.14.9.110.0220	7S.16.8.230.0420
	7S.14.9.110.0310	
	7S.14.8.120.0220	
	7S.14.8.120.0310	
	7S.14.8.230.0220	
	7S.14.8.230.0310	

Technical data

Insulation according to EN 61810-1			
Nominal voltage of supply system	V AC	230/400	
Rated insulation voltage	V AC	250	
Pollution degree		2	
Insulation between coil and contact set			
Type of Insulation		Reinforced *	Basic *
Overvoltage category		III	III
Rated impulse voltage	kV (1.2/50 µs)	6	4
Dielectric strength	V AC	4,000	2,500
			2,500
Insulation between adjacent contacts			
Type of Insulation		Reinforced *	Basic*
Overvoltage category		III	III
Rated impulse voltage	kV (1.2/50 µs)	6	4
Dielectric strength	V AC	4,000	2,500
			2,500
Insulation between open contacts			
Type of disconnection		Micro-disconnection	
Dielectric strength	V AC / kV (1.2/50 µs)	1,500 / 2.5	

* Tables below indicate, for each 7S type, those contacts (R) meeting Reinforced Insulation Overvoltage category III, those contacts (R2) meeting Reinforced Insulation Overvoltage category II, and those contacts (B) meeting Basic Insulation Overvoltage category III.

EMC specifications			Reference standard		
Burst (5/50 ns)	on supply terminals		EN 61000-4-4	4 kV	
Surge (1.2/50 µs)	on supply terminals	differential mode	EN 61000-4-5	1.5 kV	
Terminals			solid cable	stranded cable	
Max. wire size		mm ²	1 x 1.5	1 x 1.5	
		AWG	1 x 14	1 x 16	
Wire strip length		mm	9		
Other data			7S.12	7S.14	7S.16
Bounce time: NO/NC		ms	2/8	1/20	1/20
Vibration resistance (10...200) Hz: NO/NC		g	10/5	15/4	15/4
Shock resistance: NO/NC		g	20/6	25/13	25/13
Power lost to the environment	without contact current	W	0.8	0.8	0.8
	with rated current	W	1.4	2.3	2.8

Type of insulation between coil and contacts and between adjacent contacts

Code		
Type of Insulation		Overvoltage category
R	Reinforced	III
B	Basic	III
R2	Reinforced	II

7S.12....5110			
	Coil	13-14	21-22
Coil	—	R	R
13-14		—	B/R2
21-22			—

7S.14....0310					
	Coil	13-14	21-22	33-34	43-44
Coil	—	B	R	R	R
13-14		—	B	R	R
21-22			—	R	R
33-34				—	B/R2
43-44					—

7S.16....0420							
	Coil	13-14	21-22	31-32	43-44	53-54	63-64
Coil	—	B	R	R	R	R	R
13-14		—	B	R	R	R	R
21-22			—	R	R	R	R
31-32				—	B/R2	R	R
43-44					—	B/R2	R
53-54						—	B/R2
63-64							—

7S.14....0220					
	Coil	11-12	21-22	33-34	43-44
Coil	—	R	R	R	R
11-12		—	R	R	R
21-22			—	R	R
33-34				—	B/R2
43-44					—

Contact specifications

Contact diagrams	7S.12	7S.14...0220	7S.14...0310	7S.16																																																																																												
	<table border="1"> <tr><td>21</td><td>22</td><td>14</td><td>13</td></tr> <tr><td colspan="4"> </td></tr> <tr><td colspan="4"> </td></tr> <tr><td colspan="4"> </td></tr> <tr><td>A1</td><td>A1</td><td>A2</td><td>A2</td></tr> </table>	21	22	14	13													A1	A1	A2	A2	<table border="1"> <tr><td>11</td><td>12</td><td> </td><td> </td></tr> <tr><td>44</td><td>34</td><td> </td><td>22</td></tr> <tr><td colspan="4"> </td></tr> <tr><td colspan="4"> </td></tr> <tr><td>43</td><td>33</td><td>21</td><td> </td></tr> <tr><td>A1</td><td>A1</td><td>A2</td><td>A2</td></tr> </table>	11	12			44	34		22									43	33	21		A1	A1	A2	A2	<table border="1"> <tr><td>21</td><td>22</td><td>14</td><td>13</td></tr> <tr><td>44</td><td> </td><td>34</td><td> </td></tr> <tr><td colspan="4"> </td></tr> <tr><td colspan="4"> </td></tr> <tr><td>43</td><td> </td><td>33</td><td> </td></tr> <tr><td>A1</td><td>A1</td><td>A2</td><td>A2</td></tr> </table>	21	22	14	13	44		34										43		33		A1	A1	A2	A2	<table border="1"> <tr><td>21</td><td>22</td><td>14</td><td>13</td></tr> <tr><td>64</td><td>54</td><td>44</td><td>32</td></tr> <tr><td colspan="4"> </td></tr> <tr><td colspan="4"> </td></tr> <tr><td>63</td><td>53</td><td>43</td><td>31</td></tr> <tr><td>A1</td><td>A1</td><td>A2</td><td>A2</td></tr> </table>	21	22	14	13	64	54	44	32									63	53	43	31	A1	A1	A2	A2
21	22	14	13																																																																																													
A1	A1	A2	A2																																																																																													
11	12																																																																																															
44	34		22																																																																																													
43	33	21																																																																																														
A1	A1	A2	A2																																																																																													
21	22	14	13																																																																																													
44		34																																																																																														
43		33																																																																																														
A1	A1	A2	A2																																																																																													
21	22	14	13																																																																																													
64	54	44	32																																																																																													
63	53	43	31																																																																																													
A1	A1	A2	A2																																																																																													

F 7S12 - Electrical life (AC) v contact current - 7S.12

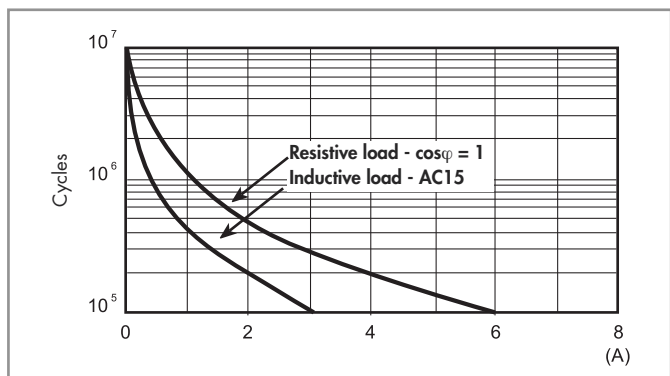

H 7S12 - Maximum DC breaking capacity - 7S.12

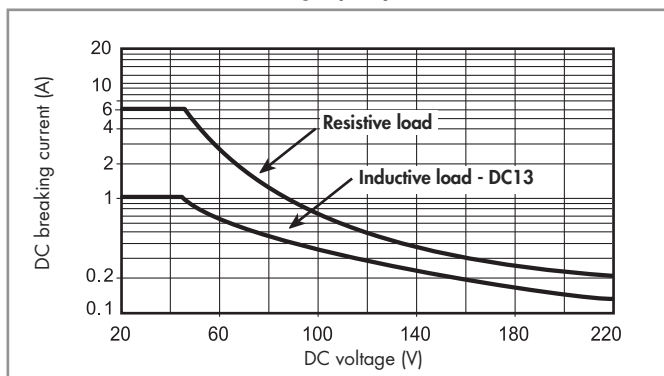

• When switching a load having voltage and current values under the curve, an electrical life of $\geq 100 \cdot 10^3$ can be expected.

F 7S16 - Electrical life (AC) v contact current - 7S.14 / 7S.16

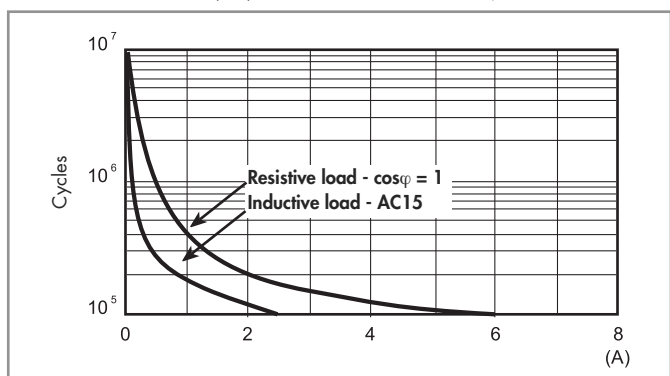

H 7S16 - Maximum DC breaking capacity - 7S.14 / 7S.16

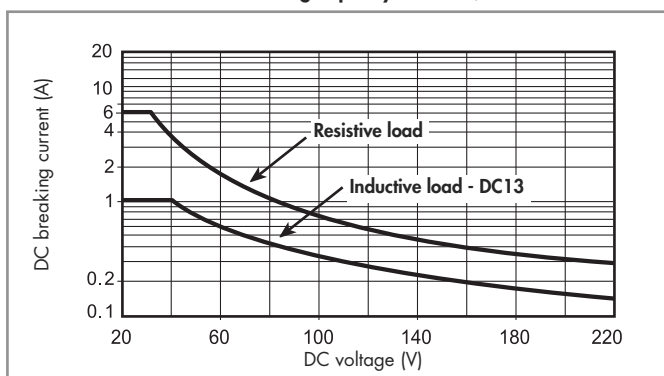

• When switching a load having voltage and current values under the curve, an electrical life of $\geq 100 \cdot 10^3$ can be expected.

Coil specifications

DC coil data - type 7S.12

Nominal voltage	Coil code	Operating range		Rated input current at U_N	Rated power at U_N
		U_{min}	U_{max}		
U_N		V	V	I_N	W
V		V	V	mA	W
12	9.012	9.6	14.4	55	0.7
24	9.024	16.8	30	38.2	0.9

AC coil data - type 7S.12

Nominal voltage	Coil code	Operating range		Rated input current at U_N	Rated power at U_N
		U_{min}	U_{max}		
U_N		V	V	I_N	VA/W
V		V	V	mA	VA/W
110...125	8.120	93	138	9.5	1.1/1
230...240	8.230	195	264	9	2/0.8

DC coil data - type 7S.14 / 7S.16

Nominal voltage	Coil code	Operating range		Rated input current at U_N	Rated power at U_N
		U_{min}	U_{max}		
U_N		V	V	I_N	W
V		V	V	mA	W
12	9.012	9.6	14.4	56	0.7
24	9.024	16.8	30	28	0.7
110	9.110	77	138	9.2	0.7

AC coil data - type 7S.14 / 7S.16

Nominal voltage	Coil code	Operating range		Rated input current at U_N	Rated power at U_N
		U_{min}	U_{max}		
U_N		V	V	I_N	VA/W
V		V	V	mA	VA/W
110...125	8.120	93	138	8.9	1.1/0.9
230...240	8.230	195	264	8.5	2/0.8

R 7S - DC coil operating range v ambient temperature - 7S.12 / 7S.14 / 7S.16

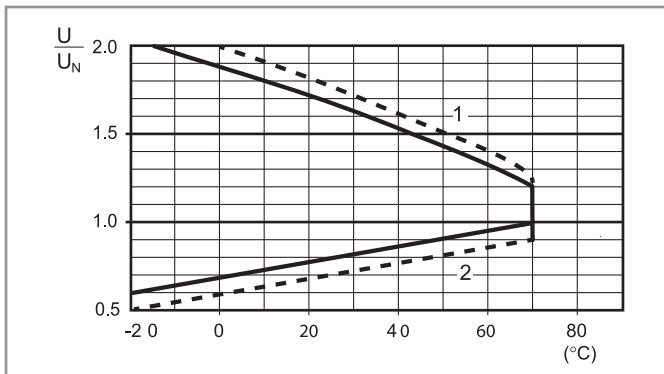

1 - Max. permitted coil voltage.
 2 - Min. pick-up voltage with coil at ambient temperature.
 - - - - 24 and 110 V DC coils only (extended range)

R 7S - AC coil operating range v ambient temperature - 7S.12 / 7S.14 / 7S.16

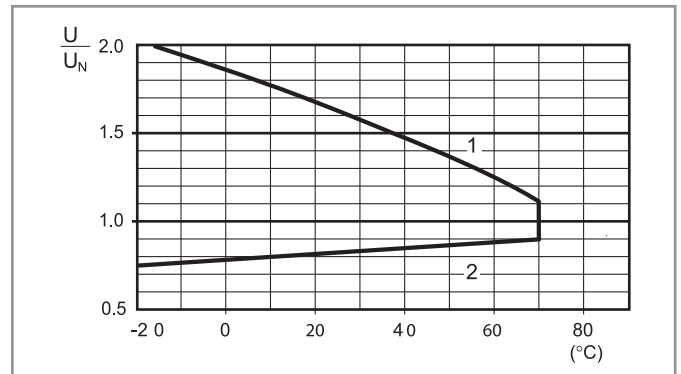

1 - Max. permitted coil voltage.
 2 - Min. pick-up voltage with coil at ambient temperature.

Outline drawings

7S
Screwless terminal

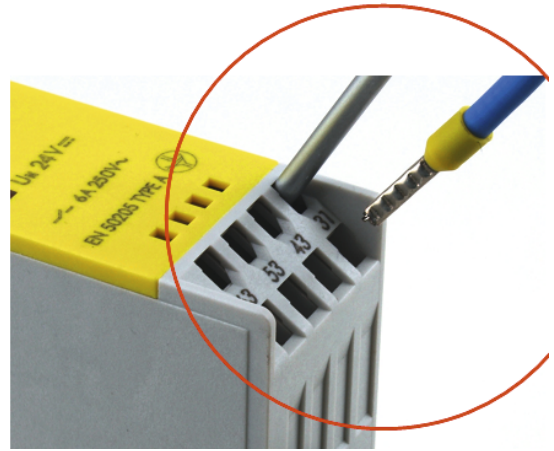
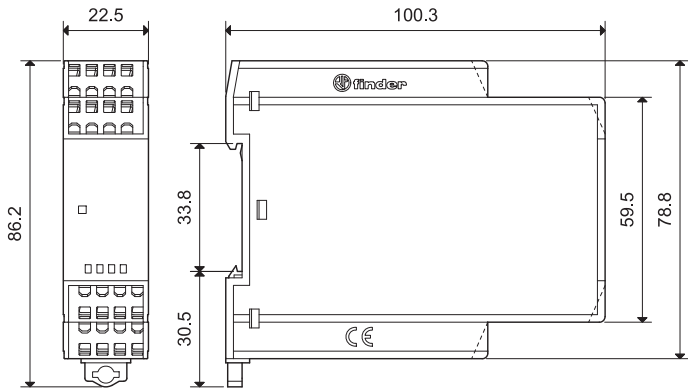

Accessories

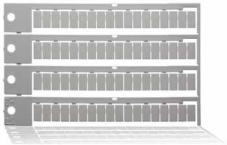

060.72

Sheet of marker tags, plastic, 72 tags, 6x12 mm

060.72