

- P.C.B. or plug-in mount
- AC, DC, sensitive DC or single bistable coil versions available
- 8 mm, 6 kV (1.2/50 µs) between coil and contacts
- Ambient temperature + 85 °C
- RT III (wash tight) version available
- Sockets and accessories: see 95, 99 and 86 series

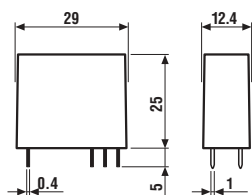

* For 400 V applications, where requirements for pollution degree 2 are met.

	40.31	40.51	40.52
	- 1 pole, 10 A - 3.5 mm pinning - P.C.B./for use with 95 series sockets	- 1 pole, 10 A - 5 mm pinning - P.C.B./for use with 95 series sockets	- 2 pole, 8 A - 5 mm pinning - P.C.B./for use with 95 series sockets
	<p style="text-align: center;">Copper side view</p>	<p style="text-align: center;">Copper side view</p>	<p style="text-align: center;">Copper side view</p>
Contact specifications			
Contact configuration	1 CO (SPDT)	1 CO (SPDT)	2 CO (DPDT)
Rated current/Maximum peak current A	10/20	10/20	8/15
Rated voltage/Maximum switching voltage V AC	250/400*	250/400*	250/250
Rated load in AC1 VA	2,500	2,500	2,000
Rated load in AC15 (230 V AC) VA	500	500	400
Single phase motor rating (230 V AC) kW	0.37	0.37	0.3
Breaking capacity in DC1: 30/110/220 V A	10/0.3/0.12	10/0.3/0.12	8/0.3/0.12
Minimum switching load mW (V/mA)	300 (5/5)	300 (5/5)	300 (5/5)
Standard contact material	AgNi	AgNi	AgNi
Coil specifications			
Nominal voltage (U _N) V AC (50/60 Hz)	6 - 12 - 24 - 48 - 60 - 110 - 120 - 230 - 240		
V DC	5 - 6 - 7 - 9 - 12 - 14 - 18 - 21 - 24 - 28 - 36 - 48 - 60 - 90 - 110 - 125		
Rated power AC/DC/sens. DC VA [50 Hz]/W/W	1.2/0.65/0.5	1.2/0.65/0.5	1.2/0.65/0.5
Operating range AC	(0.8...1.1)U _N		
DC/sens. DC	(0.73...1.5)U _N / (0.73...1.75)U _N		
Holding voltage AC/DC	0.8 U _N / 0.4 U _N		
Must drop-out voltage AC/DC	0.2 U _N / 0.1 U _N		
Technical data			
Mechanical life AC/DC cycles	10 · 10 ⁶ / 20 · 10 ⁶		
Electrical life at rated load AC1 cycles	200 · 10 ³		
Operate/release time ms	7/3 - (12/4 sensitive)		
Insulation according to EN 61810-1 ed. 2	4 kV/3		
Insulation between coil and contacts (1.2/50 µs) kV	6 (8 mm)		
Dielectric strength between open contacts V AC	1,000		
Ambient temperature range °C	-40...+85		
Environmental protection	RT II**		
Approvals (according to type):			

** See page 202 "Guidelines for automatic flow solder processes".

- P.C.B. or plug-in mount
- AC, DC, sensitive DC or single bistable coil versions available
- 8 mm, 6 kV (1.2/50 μ s) between coil and contacts
- Ambient temperature + 85 °C
- RT III (wash tight) version available
- Sockets and accessories: see 95, 99 and 86 series

40

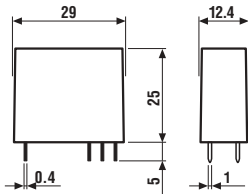

- * For 400 V applications, where requirements for pollution degree 2 are met.
- ** With the AgSnO₂ material the maximum peak current is 100 A - 5 ms on NO (nPST-NO) contact.

	40.61	40.xx.6
	<ul style="list-style-type: none"> - 1 pole, 16 A - 5 mm pinning - P.C.B./for use with 95 series sockets 	<ul style="list-style-type: none"> - Bistable version (1 coil) - P.C.B./for use with 95 series sockets
	<p style="text-align: center;">Copper side view</p>	<p>Bistable version (1 coil) types:</p> <p style="text-align: center;">40.31.6... 40.51.6... 40.52.6... 40.61.6...</p> <p style="text-align: center;">For wiring diagrams see page 28</p>
Contact specifications		
Contact configuration	1 CO (SPDT)	
Rated current/Maximum peak current	A	16/30**
Rated voltage/Maximum switching voltage V AC	250/400*	See relays
Rated load in AC1	VA	4,000
Rated load in AC1.5 (230 V AC)	VA	750
Single phase motor rating (230 V AC)	kW	0.55
Breaking capacity in DC1: 30/110/220 V	A	16/0.3/0.12
Minimum switching load	mW (V/mA)	500 (10/5)
Standard contact material	AgCdO	
Coil specifications		
Nominal voltage (U _N)	V AC (50/60 Hz)	6 - 12 - 24 - 48 - 60 - 110 - 120 - 230 - 240
	V DC	***See below
Rated power AC/DC/sens. DC	VA (50 Hz)/W/W	1.2/0.65/0.5
Operating range	AC	(0.8...1.1)U _N
	DC/sens. DC	(0.73...1.5)U _N /(0.8...1.5)U _N
Holding voltage	AC/DC	0.8 U _N / 0.4 U _N
Must drop-out voltage	AC/DC	0.2 U _N / 0.1 U _N
Technical data		
Mechanical life AC/DC	cycles	10 · 10 ⁶ / 20 · 10 ⁶
Electrical life at rated load AC1	cycles	100 · 10 ³
Operate/release time	ms	7/3 - (12/4 sensitive)
Insulation according to EN 61810-1 ed. 2	kV	4 kV/3
Insulation between coil and contacts (1.2/50 μ s)	kV	6 (8 mm)
Dielectric strength between open contacts	V AC	1,000
Ambient temperature range	°C	-40...+85
Environmental protection	RT II**	

*** Nominal voltage (U_N):
5 - 6 - 7 - 9 - 12 - 14 - 18 - 21 -
24 - 28 - 36 - 48 - 60 - 90 -
110 - 125 V DC

- Plug-in or P.C.B. versions
- Sensitive DC version available
- 8 mm, 6 kV (1.2/50 μs) between coil and contacts
- Sockets and accessories: see 95 series

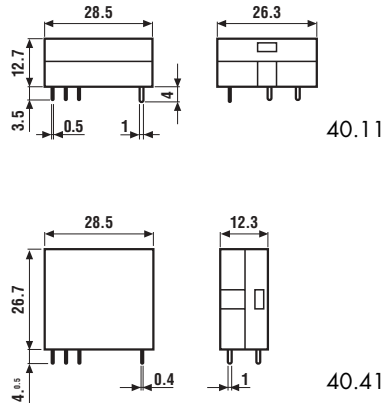

	40.11	40.11-2016	40.41
	<ul style="list-style-type: none"> - 1 pole, 10 A - 3.5 mm pinning - P.C.B. mounting 	<ul style="list-style-type: none"> - 1 pole, 16 A - 3.5 mm pinning - P.C.B. mounting 	<ul style="list-style-type: none"> - 1 pole, 10 A - 3.5 mm pinning - P.C.B./for use with 95 series sockets
	<p>Copper side view</p>	<p>Copper side view</p>	<p>Copper side view</p>
Contact specifications			
Contact configuration	1 CO (SPDT)	1 CO (SPDT)	1 CO (SPDT)
Rated current/Maximum peak current A	10/20	16/30	10/20
Rated voltage/Maximum switching voltage V AC	250/400*	250/400*	250/400*
Rated load in AC1 VA	2,500	4,000	2,500
Rated load in AC15 (230 V AC) VA	500	750	500
Single phase motor rating (230 V AC) kW	0.37	0.55	0.37
Breaking capacity in DC1: 30/110/220 V A	10/0.3/0.12	16/0.3/0.12	10/0.3/0.12
Minimum switching load mW (V/mA)	300 (5/5)	500 (10/5)	300 (5/5)
Standard contact material	AgCdO	AgCdO	AgCdO
Coil specifications			
Nominal voltage (U _N) V AC (50/60 Hz)	—	—	—
V DC	6 - 12 - 24 - 48 - 60	6 - 12 - 24 - 48	6 - 12 - 24 - 48 - 60
Rated power AC/DC/sens. DC VA [50 Hz]/W/W	—/—/0.5	—/—/0.5	—/—/0.5
Operating range AC	—	—	—
DC/sens. DC	—/(0.73...1.75)U _N	—/(0.73...1.75)U _N	—/(0.73...1.75)U _N
Holding voltage AC/DC	—/0.4 U _N	—/0.4 U _N	—/0.4 U _N
Must drop-out voltage AC/DC	—/0.1 U _N	—/0.1 U _N	—/0.1 U _N
Technical data			
Mechanical life AC/DC cycles	—/20 · 10 ⁶	—/20 · 10 ⁶	—/20 · 10 ⁶
Electrical life at rated load AC1 cycles	200 · 10 ³	50 · 10 ³	200 · 10 ³
Operate/release time ms	12/4	12/4	12/4
Insulation according to EN 61810-1 ed. 2	4 kV/3	4 kV/3	4 kV/3
Insulation between coil and contacts (1.2/50 μs) kV	6 (8 mm)	6 (8 mm)	6 (8 mm)
Dielectric strength between open contacts V AC	1,000	1,000	1,000
Ambient temperature range °C	-40...+70	-40...+70	-40...+70
Environmental protection	RT I	RT I	RT I
Approvals (according to type):	GOST		

* For 400 V applications, where requirements for pollution degree 2 are met.

ORDERING INFORMATION

Example: a 40 series P.C.B. relay with 2 CO (SPDT) contacts, with coil rated at 230 V AC.

4 0 . 5 2 . 8 . 2 3 0 . A B C D

Series ————

Type
 1 = P.C.B. - 3.5 mm pinning, flat
 3 = P.C.B. - 3.5 mm pinning
 4 = P.C.B. - 3.5 mm pinning
 5 = P.C.B. - 5 mm pinning
 6 = P.C.B. - 5 mm pinning

No. of poles ————

1 = 1 pole
 for: 40.11, 10 A
 40.31, 10 A
 40.41, 10 A
 40.51, 10 A
 40.61, 16 A

2 = 2 pole
 for 40.52, 8 A

Coil version ————

6 = AC/DC bistable
 7 = Sensitive DC
 8 = AC (50/60 Hz)
 9 = DC

Coil voltage ————
 see coil specifications

A: Contact material
 0 = Standard AgNi
 for: 40.31/51/52
 AgCdO for 40.61
 2 = AgCdO (standard
 for 40.11/41)
 4 = AgSnO₂
 5 = AgNi + Au (5 μm)

B: Contact circuit
 0 = CO (nPDT)
 3 = NO (nPST)

D: Special versions
 0 = Standard
 1 = Wash tight (RT III)
 3 = High temperature (+ 125 °C)
 wash tight

C: Options
 0 = None
 16 = with rated current 16 A (for 40.11)

Only combinations in the same row are possible

Preferred versions

	coil version	A	B	C	D
40.11/41	sens.DC	2	0	0	0
40.31/51	AC/DC/sens.DC	0	0	0	0
40.52	AC/DC/sens.DC	0	0	0	0
40.61	AC/DC/sens.DC	0	0	0	0

All versions

	coil version	A	B	C	D
40.11	sens. DC	2	0	0	0
40.11	sens. DC	2	0	16	/
40.41	sens. DC	2	0 - 3	0	0
40.31/51	AC/sens. DC	0 - 2 - 5	0 - 3	0	0 - 1
40.31/51	DC	0 - 2 - 5	0 - 3	0	0 - 1 - 3
40.52	AC/sens. DC	0 - 2 - 5	0 - 3	0	0 - 1
40.52	DC	0 - 2 - 5	0 - 3	0	0 - 1 - 3
40.61	AC/sens. DC	0 - 4	0 - 3	0	0 - 1
40.61	DC	0 - 4	0 - 3	0	0 - 1 - 3
40.31/51/ 52/61	bistable	0	0	0	0

TECHNICAL DATA

INSULATION

Insulation according to EN 61810-1 ed. 2	insulation rated voltage	V	250
	rated impulse withstand voltage	kV	4
	pollution degree		3 (1 CO/SPDT) 2 (2 CO/DPDT)
	overvoltage category		III
Dielectric strength between adjacent contacts	V AC		2,000

CONDUCTED DISTURBANCE IMMUNITY

Burst (5...50)ns, 5 kHz, on A1 - A2	EN 61000-4-4	level 4 (4 kV)
Surge (1.2/50 μs) on A1 - A2 (differential mode)	EN 61000-4-5	level 3 (2 kV)

OTHER DATA

Bounce time: NO/NC	ms	2/5
Vibration resistance (10...55)Hz, max. ± 1 mm: NO/NC	g/g	10/4 (for 1 CO or SPDT) 3/3 (for 2 CO or DPDT)
Power lost to the environment	without contact current	W 0.6
	with rated current	W 1.2 (40.11/31/41/51) 2 (40.61/52/40.11-2016)
Recommended distance between relays mounted on P.C.B.s	mm	≥ 5

CONTACT SPECIFICATIONS

F 40 (Types 40.31/51/52/61)

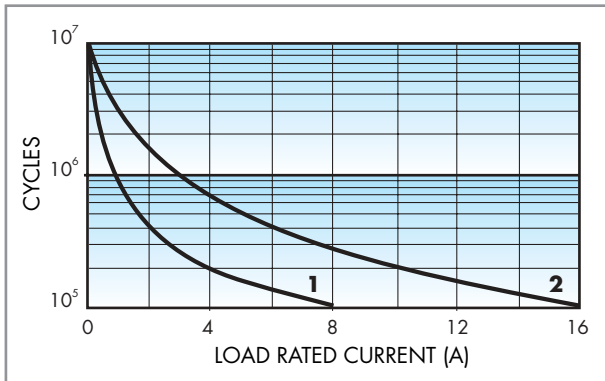

Electrical life vs AC1 load.

1 - Type 40.52 (8 A)

2 - Types 40.31, 40.51 (10 A)
Type 40.61 (16 A)

F 40 (Types 40.11/41)

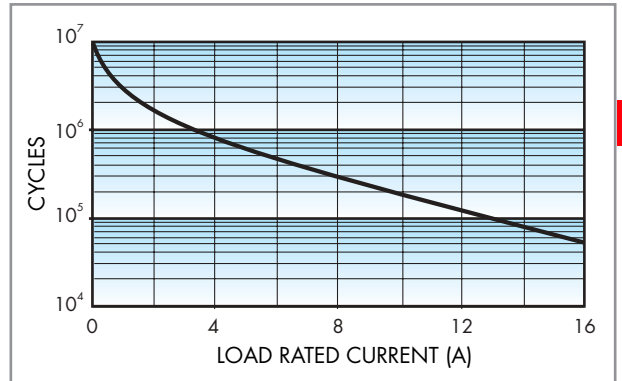

Electrical life vs AC1 load.

Types 40.11, 40.41 (10 A)
Types 40.11-2016 (16 A)

H 40

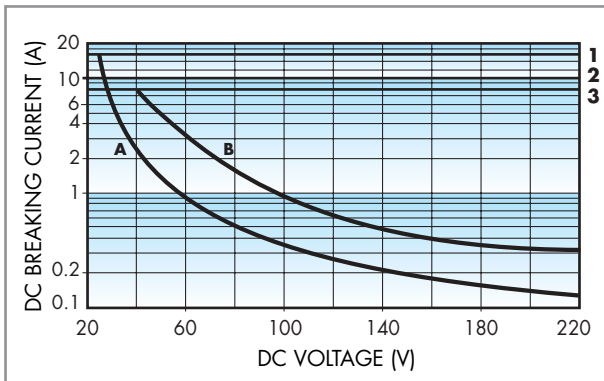

Breaking capacity for DC1 load.

1 - Type 40.61

2 - Types 40.11, 40.31, 40.41, 40.51

3 - Type 40.52

A - Load applied to 1 contact

B - Load applied to 2 contacts in series

- When switching a resistive load (DC1) having voltage and current values under the curve the expected electrical life is $\geq 100 \cdot 10^3$ cycles.

- In case of DC13 loads the connection of a diode in parallel with the load will permit the same electrical life as for a DC1 load.

Note: the release time of load will be increase.

COIL SPECIFICATIONS

DC VERSION DATA (0.65 W standard - Types 40.31/51/52/61)

Nominal voltage U_N	Coil code	Operating range		Resistance R	Rated coil consumption I at U_N
		U_{min}	U_{max}		
V		V	V	Ω	mA
5	9.005	3.65	7.5	38	130
6	9.006	4.4	9	55	109
7	9.007	5.1	10.5	75	94
9	9.009	6.6	13.5	125	72
12	9.012	8.8	18	220	55
14	9.014	10.2	21	300	47
18	9.018	13.1	27	500	36
21	9.021	15.3	31.5	700	30
24	9.024	17.5	36	900	27
28	9.028	20.5	42	1,200	23
36	9.036	26.3	54	2,000	18
48	9.048	35	72	3,500	14
60	9.060	43.8	90	5,500	11
90	9.090	65.7	135	12,500	7.2
110	9.110	80.3	165	18,000	6.2
125	9.125	91.2	187.5	23,500	5.3

40

DC VERSION DATA (0.5 W sensitive - Types 40.31/51/52/61)

Nominal voltage U_N	Coil code	Operating range		Resistance R	Rated coil consumption I at U_N
		U_{min}^*	U_{max}^{**}		
V		V	V	Ω	mA
5	7.005	3.7	8.8	50	100
6	7.006	4.4	10.5	75	80
7	7.007	5.1	12.2	100	70
9	7.009	6.6	15.8	160	56
12	7.012	8.8	21	300	40
14	7.014	10.2	24.5	400	35
18	7.018	13.2	31.5	650	27.7
21	7.021	15.4	36.9	900	23.4
24	7.024	17.5	42	1,200	20
28	7.028	20.5	49	1,600	17.5
36	7.036	26.3	63	2,600	13.8
48	7.048	35	84	4,800	10
60	7.060	43.8	105	7,200	8.4
90	7.090	65.7	157	16,200	5.6
110	7.110	80.3	192	23,500	4.7
125	7.125	91.2	218.7	32,000	3.9

* $U_{min} = 0.8 U_N$ for 40.61

** $U_{max} = 1.5 U_N$ for 40.61

DC VERSION DATA (0.5 W sensitive - Types 40.11/41)

Nominal voltage U_N	Coil code	Operating range		Resistance R	Rated coil consumption I at U_N
		U_{min}	U_{max}^*		
V		V	V	Ω	mA
6	7.006	4.4	10.5	75	80
12	7.012	8.8	21	300	40
24	7.024	17.5	42	1,200	20
48	7.048	35	84	4,600	10.4
60	7.060	43.8	105	7,200	8.3

* $U_{max} = 1.5 U_N$ for 40.11-2016

AC VERSION DATA (Types 40.31/51/52/61)

Nominal voltage U_N	Coil code	Operating range		Resistance R	Rated coil consumption I at U_N (50Hz)
		U_{min}	U_{max}		
V		V	V	Ω	mA
6	8.006	4.8	6.6	21	168
12	8.012	9.6	13.2	80	90
24	8.024	19.2	26.4	320	45
48	8.048	38.4	52.8	1,350	21
60	8.060	48	66	2,100	16.8
110	8.110	88	121	6,900	9.4
120	8.120	96	132	9,000	8.4
230	8.230	184	253	28,000	5
240	8.240	192	264	31,500	4.1

AC/DC VERSION DATA (bistable - Types 40.31/51/52/61)

Nominal voltage U_N	Coil code	Operating range		Resistance R	Rated coil consumption I at U_N	DC: Release resistance** R_{DC}
		U_{min}	U_{max}			
V		V	V	Ω	mA	Ω
5	6.005	4	5.5	23	215	37
6	6.006	4.8	6.6	33	165	62
12	6.012	9.6	13.2	130	83	220
24	6.024	19.2	26.4	520	40	910
48	6.048	38.4	52.8	2,100	21	3,600
110	6.110	88	121	11,000	10	16,500

** R_{DC} = Resistance in DC, $R_{AC} = 1.3 \times R_{DC}$ 1W

COIL SPECIFICATIONS

R 40 DC

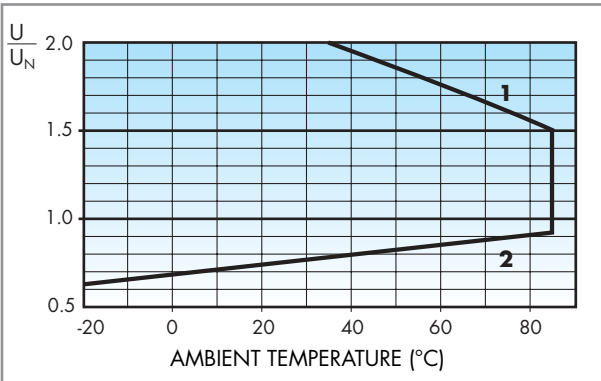

Operating range vs ambient temperature.
 1 - Max coil voltage permitted.
 2 - Min pick-up voltage with coil at ambient temperature.

R 40 AC

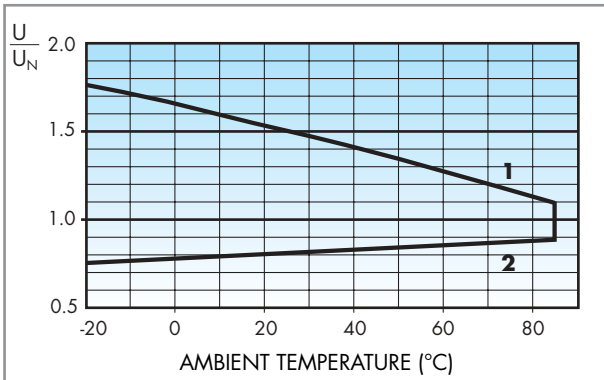

Operating range vs ambient temperature.
 1 - Max coil voltage permitted.
 2 - Min pick-up voltage with coil at ambient temperature.

R 40 sens. DC (Types 40.31/51/52/61)

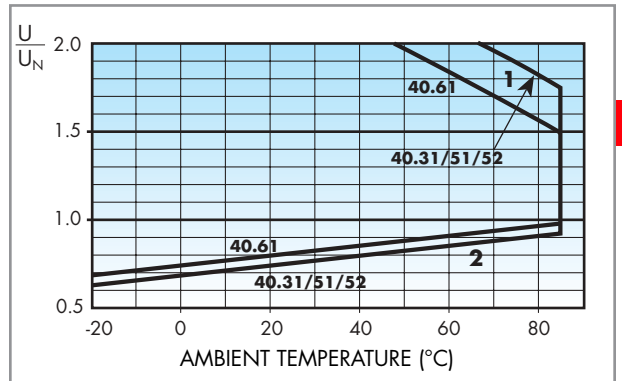

Operating range vs ambient temperature.
 1 - Max coil voltage permitted.
 2 - Min pick-up voltage with coil at ambient temperature.

R 40 sens. DC (Types 40.11/41)

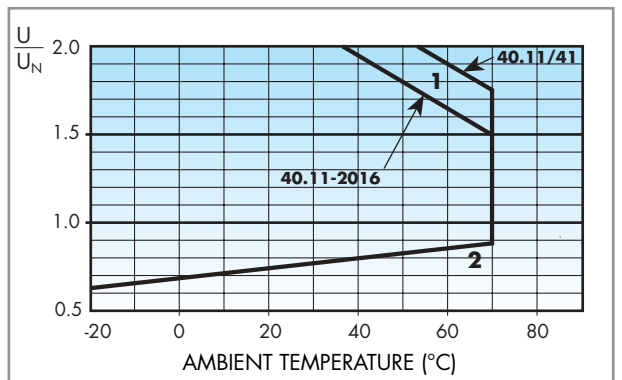

Operating range vs ambient temperature.
 1 - Max coil voltage permitted.
 2 - Min pick-up voltage with coil at ambient temperature.

Wiring diagram for 40 series bistable coil version

AC Operation

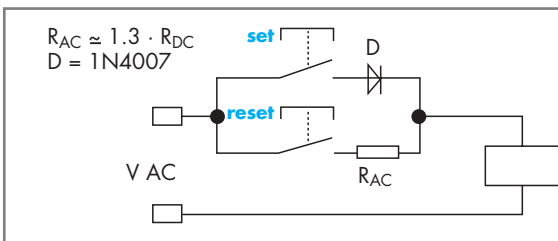

On momentary closure of the SET switch the relay is magnetised through the diode and the relay contacts transfer to the set position and remain in this position.
 On momentary closure of the RESET switch the relay is demagnetised through limiting resistor (R_{AC}) and the contacts return to the reset position.

Notes: The minimum SET or RESET impulse time is 20 ms. The maximum time can be continuous. In practice, always ensure that the SET and RESET contacts cannot be operated simultaneously.

DC Operation

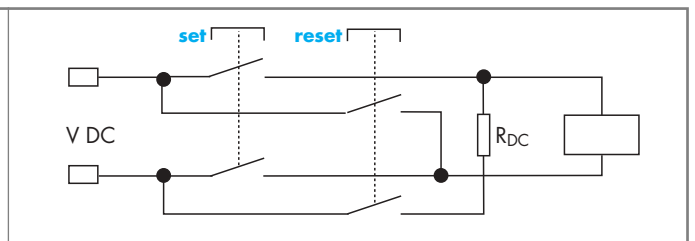

On momentary closure of the SET switch the relay is magnetised and the relay contacts transfer to the set position and remain in this position.
 On momentary closure of the RESET switch the relay is demagnetised through limiting resistor (R_{DC}) and the contacts return to the reset position.



95.05

Relay type	40.31		40.51/ 52/ 61	
Colour	BLUE	BLACK	BLUE	BLACK
Clamp terminal socket: panel or 35 mm rail (EN 50022) mount, retaining clip 095.01 supplied with socket packaging code SPA	95.03	95.03.0	95.05	95.05.0
Plastic retaining and release clip	095.01	095.01.0	095.01	095.01.0
Metal retaining clip	095.71			
8-way jumper link for 95.03 and 95.05 sockets	095.18	095.18.0	095.18	095.18.0
Identification tag	095.00.4			
Modules (see table below)	99.02			
Timer modules (see table below)	86.10, 86.20			
Sheet of marker tags for retaining and release clip 095.01	060.72			

40

Approvals (according to type):



- Rated values: 10 A - 250 V with a current >10 A, the contact terminal must be connected in parallel (21 with 11, 24 with 12)
- Insulation: ≥ 6 kV (1.2/50 μ s) between coil and contacts
- Protection category: IP 20
- Ambient temperature: (-40...+70) $^{\circ}$ C
- Screw torque: 0.5 Nm
- Wire strip length: 8 mm
- Max wire size:

	solid wire	stranded wire
mm ²	1x6 / 2x2.5	1x4 / 2x2.5
AWG	1x10 / 2x14	1x12 / 2x14

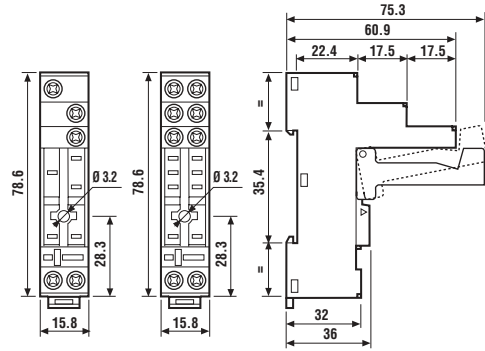

095.01



060.72

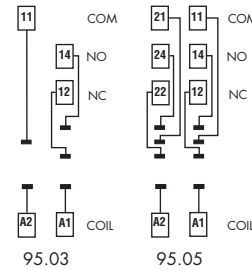

FOR 95.03 AND 95.05 SOCKETS:



095.18

8-way jumper link	095.18
--------------------------	--------

- Rated values: 10 A - 250 V

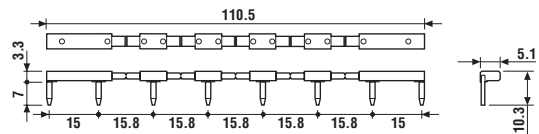

86.10

86 series module timers (see technical data pages 151/156)	BLUE
Mono-function: (12...24)V AC/DC; function AI; (1.5s...60min)	86.10.0.024.0000
Mono-function: (12...24)V AC/DC; function DI; (1.5s...60min)	86.20.0.024.0000

Approvals (according to type): GOST



99.02

Approvals (according to type):



99.02 coil indication and EMC suppression modules (see technical data page 209)		BLUE*
Diode** (+A1, standard polarity)	(6...220)V DC	99.02.3.000.00
LED	(6...24)V DC/AC	99.02.0.024.59
LED	(28...60)V DC/AC	99.02.0.060.59
LED	(110...240)V DC/AC	99.02.0.230.59
LED + Diode** (+A1, standard polarity)	(6...24)V DC	99.02.9.024.99
LED + Diode** (+A1, standard polarity)	(28...60)V DC	99.02.9.060.99
LED + Diode** (+A1, standard polarity)	(110...220)V DC	99.02.9.220.99
LED + Varistor	(6...24)V DC/AC	99.02.0.024.98
LED + Varistor	(28...60)V DC/AC	99.02.0.060.98
LED + Varistor	(110...240)V DC/AC	99.02.0.230.98
RC circuit	(6...24)V DC/AC	99.02.0.024.09
RC circuit	(28...60)V DC/AC	99.02.0.060.09
RC circuit	(110...240)V DC/AC	99.02.0.230.09
Residual current by-pass (62 k Ω /1W)	(110...240)V AC	99.02.8.230.07

* Modules in Black housing are available on request.

**For DC supply, apply the positive to terminal A1.



95.85.3

Approvals
(according to type):



GOST

- Rated values: 10 A - 250 V
with a current >10 A, the contact terminal must be connected in parallel (21 with 11, 24 with 14, 22 with 12)
- Insulation: ≥ 6 kV (1.2/50 μ s)
between coil and contacts (only for 95.83.3)
- Protection category: IP 20
- Ambient temperature: (-40...+70)°C
- Srew torque: 0.5 Nm
- Wire strip length: 7 mm
- Max wire size:

	solid wire	stranded wire
mm ²	1x6 / 2x2.5	1x4 / 2x2.5
AWG	1x10 / 2x14	1x12 / 2x14

Relay type	40.31		40.51, 40.52, 40.61	
Colour	BLUE	BLACK	BLUE	BLACK
Clamp terminal socket: panel or 35 mm rail (EN 50022) mount retaining clip 095.91.3 supplied with socket packaging code SPA	95.83.3	95.83.30	95.85.3	95.85.30
Metal retaining clip	095.71			
Plastic retaining and release clip	095.91.3			
8-way jumper link for 95.83.3 and 95.85.3 sockets	095.08	095.08.0	095.08	095.08.0
Modules (see table below)	99.80			
Sheet of marker tags for retaining and release clip 095.91.3	060.72			

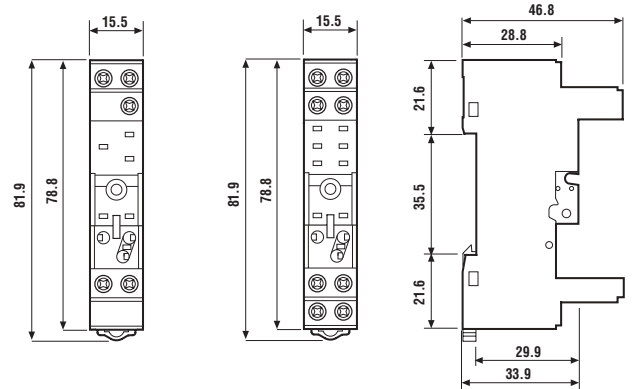
40

095.91.3



060.72

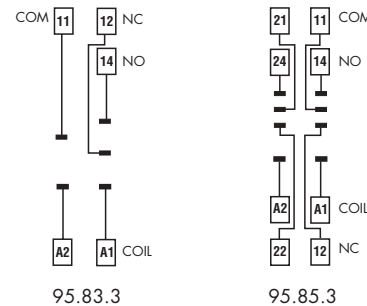

FOR 95.83.3 AND 95.85.3 SOCKETS:



095.08

8-way jumper link	095.08
--------------------------	--------

- Rated values: 10 A - 250 V

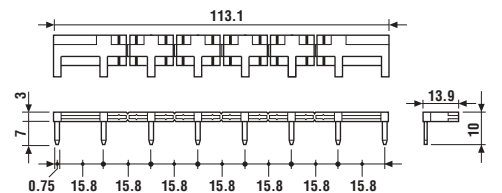

99.80

Approvals
(according to type):

GOST

* Modules in Black housing are available on request.

**For DC supply, apply the positive to terminal A1.

99.80 coil indication and EMC suppression modules (see technical data page 209)		BLUE*
Diode** (+A1, standard polarity)	(6...220)V DC	99.80.3.000.00
LED	(6...24)V DC/AC	99.80.0.024.59
LED	(28...60)V DC/AC	99.80.0.060.59
LED	(110...240)V DC/AC	99.80.0.230.59
LED + Diode** (+A1, standard polarity)	(6...24)V DC	99.80.9.024.99
LED + Diode** (+A1, standard polarity)	(28...60)V DC	99.80.9.060.99
LED + Diode** (+A1, standard polarity)	(110...220)V DC	99.80.9.220.99
LED + Varistor	(6...24)V DC/AC	99.80.0.024.98
LED + Varistor	(28...60)V DC/AC	99.80.0.060.98
LED + Varistor	(110...240)V DC/AC	99.80.0.230.98
RC circuit	(6...24)V DC/AC	99.80.0.024.09
RC circuit	(28...60)V DC/AC	99.80.0.060.09
RC circuit	(110...240)V DC/AC	99.80.0.230.09
Residual current by-pass (62 k Ω /1W)	(110...240)V AC	99.80.8.230.07

Green LED is standard.
Red LED available on request.



Relay type	40.31, 40.41		40.51, 40.52, 40.61	
Colour	BLUE	BLACK	BLUE	BLACK
P.C.B. socket	95.13.2	95.13.20	95.15.2	95.15.20
retaining clip 095.51 supplied with socket packaging code SMA				
Metal retaining clip	095.51			
Plastic retaining clip	095.52			

40



Approvals
(according to type):



- Rated values: 10 A - 250 V
- Insulation: ≥ 6 kV (1.2/50 μ s)
between coil and contacts
- Protection category: IP 20
- Ambient temperature: (-40...+70) $^{\circ}$ C

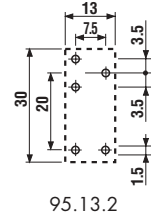
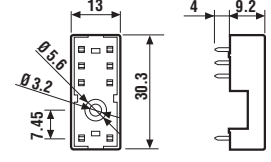
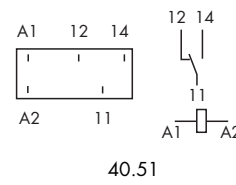
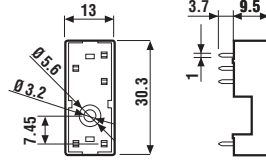
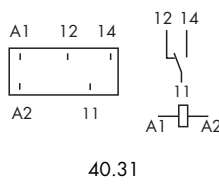

Copper side view

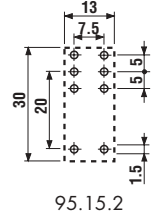
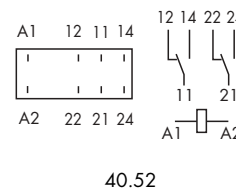

Copper side view

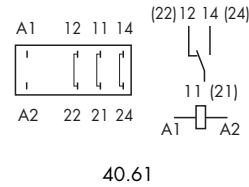

PACKAGING CODES

How to code and identify retaining clip and packaging options for sockets.

Code options according to the last three letters:

